



# AD7200 Multi-Band Wi-Fi Router

60GHz Wi-Fi to Redefine  
Home Entertainment



Talon AD7200

 800Mbps + 1733Mbps  
+4600Mbps Wi-Fi

 MU-MIMO

 Multi-Band  
(2.4/5/60GHz)

 1.4GHz Dual-  
Core CPU

# Highlights

## Wireless AD for Streaming and Sharing

The Talon AD7200 is the world's first router to support 802.11ad - the latest, most powerful wireless technology.

### Instantly



### In Seconds



### In Minutes



Transfer HD movie



## Multi-Band for Whole-Home Coverage

Multiple bands reach an unprecedented 7.2Gbps to run all your devices at one time (4600Mbps on 60GHz, 1733Mbps on 5GHz, 800Mbps on 2.4GHz).

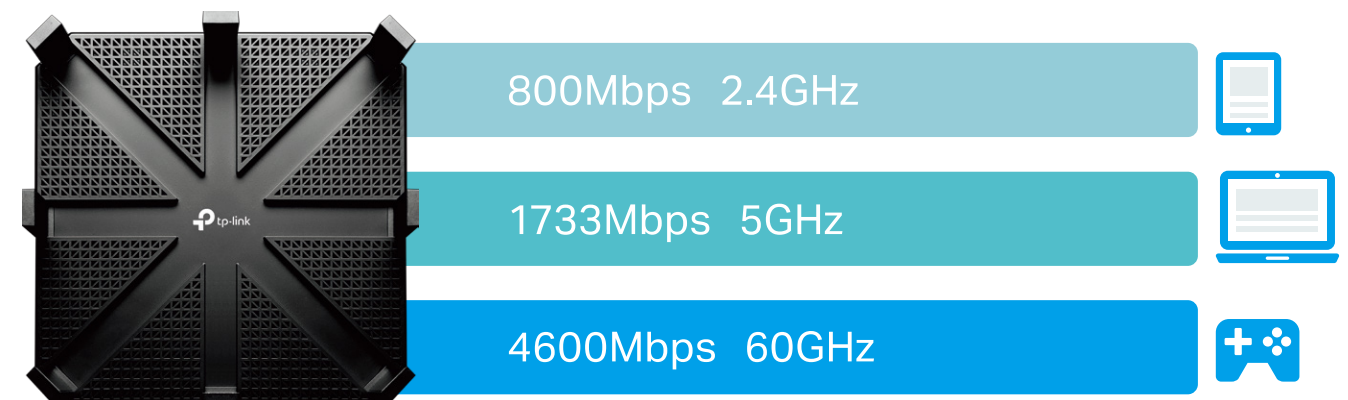

# Highlights

## Leading-Edge Antenna Design

Eight high-gain antennas (seven external, one internal) and one external 60GHz antenna array create strong Wi-Fi connections across your home.

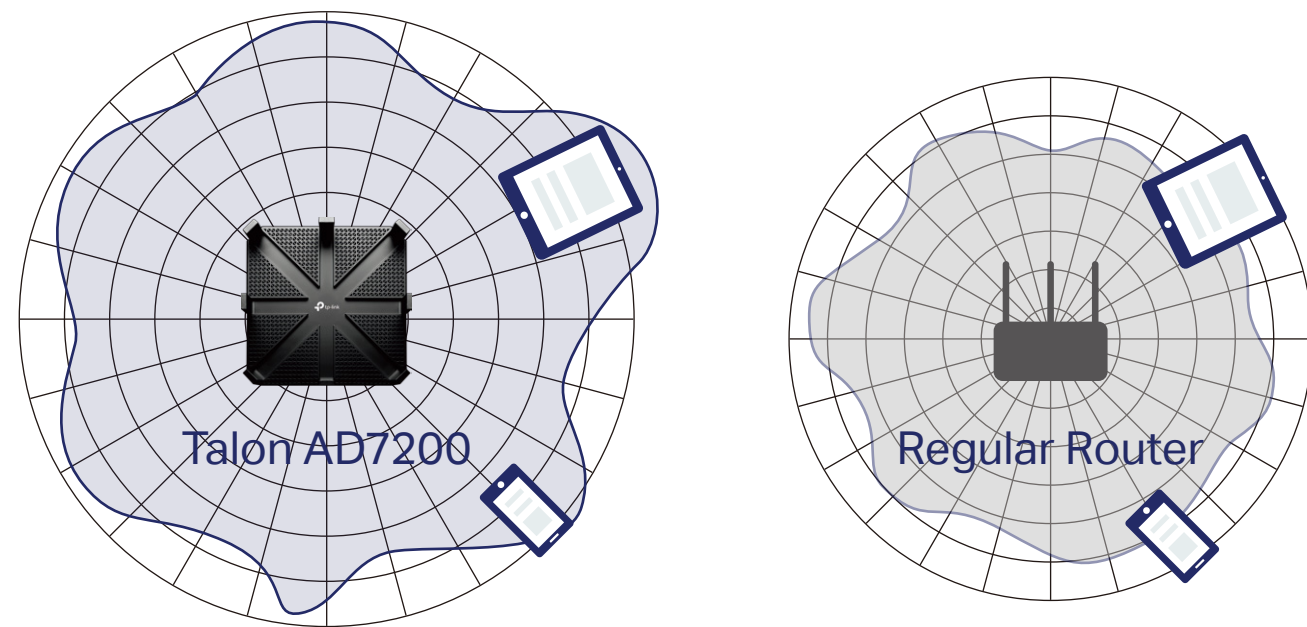

## MU-MIMO for Faster Connection

MU-MIMO lets the Talon AD7200 communicate with multiple devices at one time on its 2.4GHz and 5GHz bands for 3x faster connections.

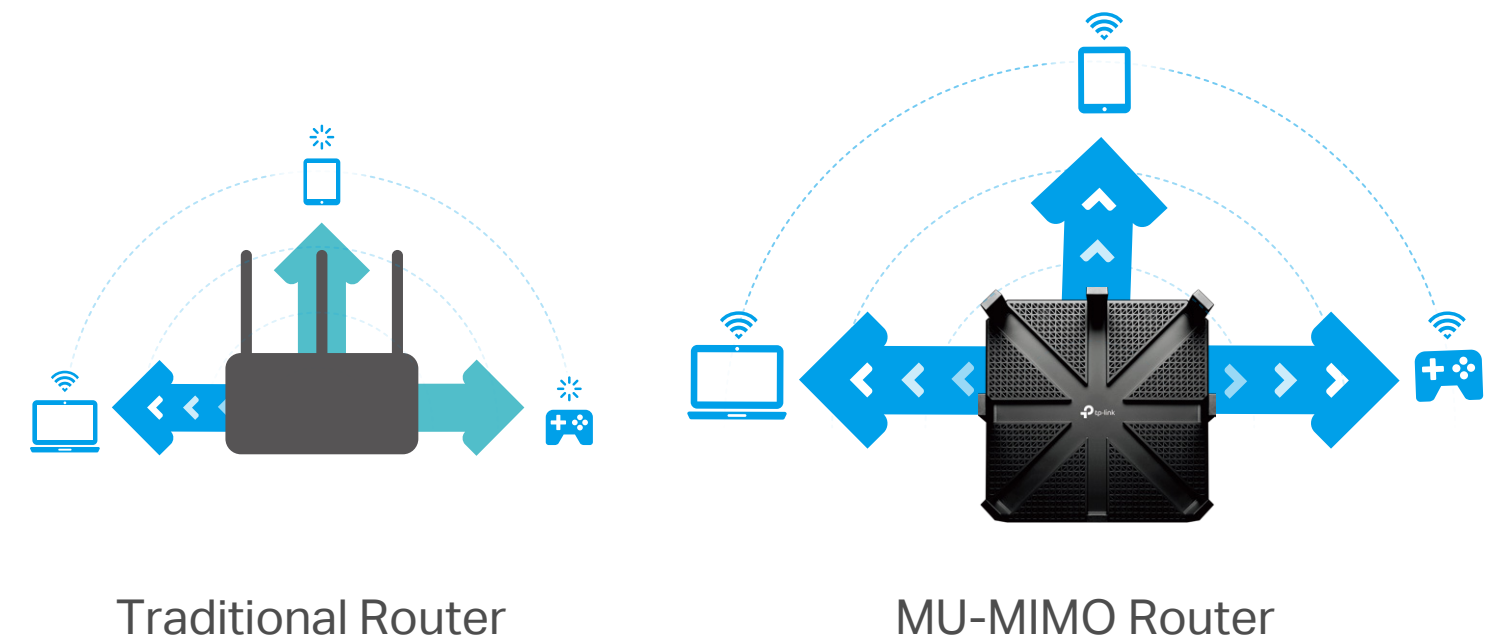



# Features



## Speed

- **Ultimate Wireless Speed** – Combined wireless speeds up to 800Mbps over 2.4GHz, 1733Mbps over 5GHz and 4600Mbps over 60GHz
- **Support 802.11 ac** – Provides a data transfer rate 3 times faster than 802.11n for each stream
- **1.4GHz Dual-Core CPU** – A 1.4GHz dual-core CPU balances the demands of your devices and improves NAT throughput to keep connections fast and continuous

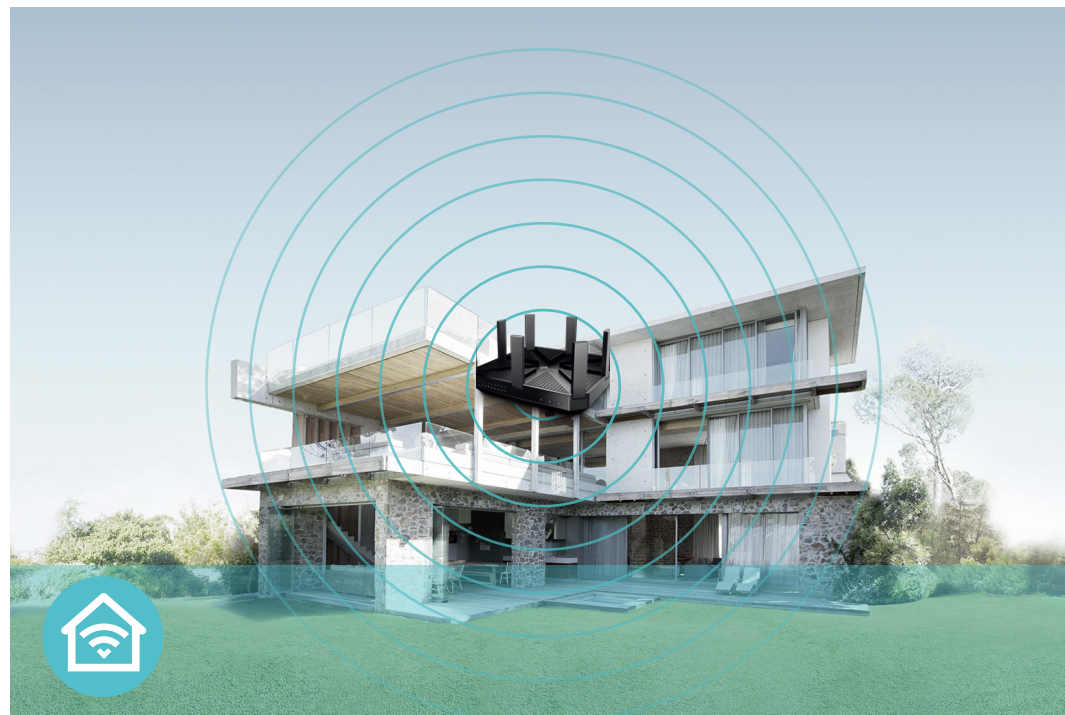

## Wi-Fi Range

- **Ultimate Range Wi-Fi** – 8 high-performance antennas with a high-powered amplifier ensure the widespread Wi-Fi coverage and a stable connection
- **Wi-Fi with Beamforming** – Beamforming technology locates the connected devices and further improves the Talon AD7200's range and the signal strength to each mobile device, delivering a more reliable and efficient wireless connection



## Reliability

- **Simultaneous Multi Band** – Separate Wi-Fi bands enable more devices to connect to your network without a drop in performance
- **Easy Bandwidth Management** – Advanced QoS makes it easier for you to manage the bandwidth of connected devices



# Features



## Ease of Use

- Intuitive Web UI – Ensures quick and simple Installation without hassle
- Fast Encryption – One-touch WPA wireless security encryption with the WPS button
- Easy On/Off – Turn on/off wireless radio using the Wi-Fi button; turn on/off LEDs using the LED button
- Power On/Off – Conveniently power on or off your router as required
- Hassle-free Management with Tether App – Network management is made easy with the TP-Link Tether App, available on any Android and iOS device
- Online Upgrade – Keeps you informed of the latest firmware and allows online upgrade on the web UI



## Security

- Guest Network – Keep your main network secure by creating a separate network for friends and visitors
- Access Control – Establish a whitelist or blacklist to allow or restrict certain devices to access the internet
- Parental Controls – Restrict internet access time and contents for children devices
- Encryptions for Secure Network – WPA-PSK and WPA2-PSK encryptions provide active protection against security threats



## Easy Sharing

- Dual USB 3.0 Ports for Fast Sharing – Dual USB 3.0 ports make it easy to share photos, videos, and music across your home network. Through the router's FTP server, you can also access your files and media from network devices remotely
- 10x Faster Transfer Speed – The USB 3.0 port provides up to 10x faster USB hard drive access than previous generation USB 2.0 connections
- Built-in Print Server – Allows wireless printing from multiple computers (works in conjunction with a USB printer)
- Built-in Media Server – Allows you to play music, watch videos and view photos from any device on your network



# Specifications

## Hardware

- Ethernet Ports: 4 10/100/1000Mbps LAN Ports, 1 10/100/1000Mbps WAN Port
- USB Ports: 2 USB 3.0 Ports
- Buttons: Wi-Fi On/Off Button, LED On/Off Button, Power On/Off Button, Reset Button, WPS Button
- Antennas: 8 External Antennas, 1 Internal Antenna
- External Power Supply: 12V/4.2A (US version), 12V/4A (EU version)
- Dimensions (W x D x H): 9.1× 9.1×1.7 in. (230×230×43mm)

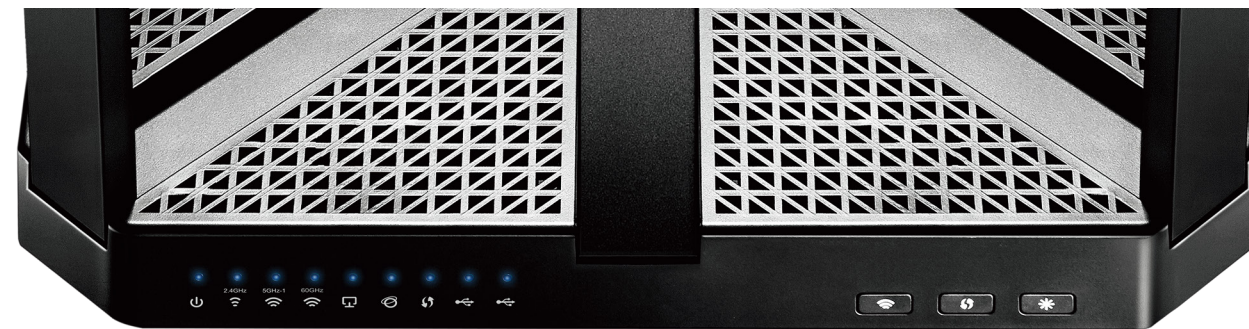

LEDs

Wi-Fi WPS LED

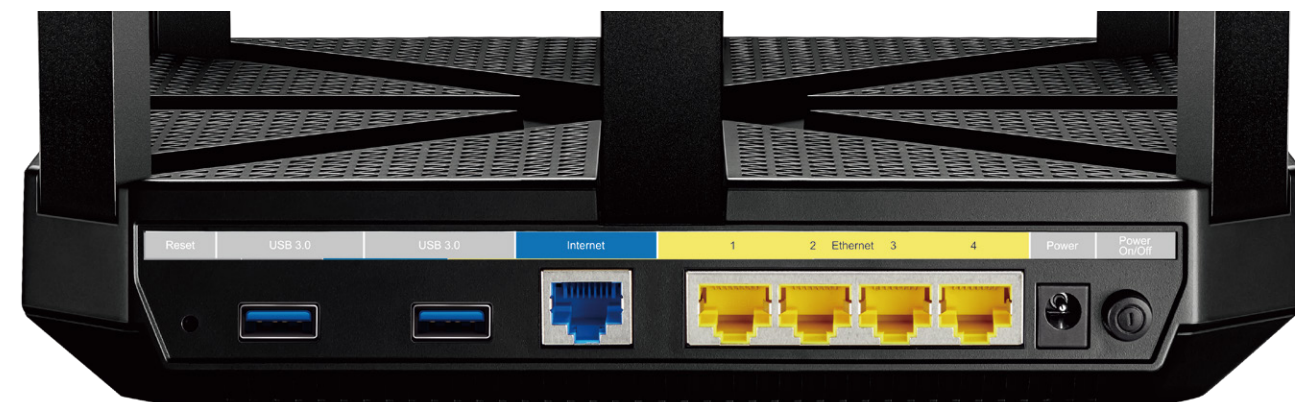

Reset

USB 3.0

Internet Access

Gigabit LAN Ports

Power

Power On/Off

## Wireless

- Wireless Standards: IEEE 802.11ad 60GHz, IEEE 802.11ac/n/a 5GHz, IEEE 802.11b/g/n 2.4GHz
- Frequency: 2.4GHz, 5GHz and 60GHz
- Signal Rate: 800Mbps on 2.4GHz, 1733Mbps on 5GHz, 4600Mbps on 60GHz
- Transmit Power:  
CE: <20dBm(2.4GHz), <23dBm(5GHz);  
FCC: <30dBm(2.4GHz & 5GHz), 24dBm EIRP (60GHz)
- Reception Sensitivity:  
5GHz:  
11a 6Mbps: -94dBm, 11a 54Mbps: -76dBm  
11ac VHT20\_MCS0: -93dBm, 11ac VHT20\_MCS8: -69dBm  
11ac VHT40\_MCS0: -90dBm, 11ac VHT40\_MCS9: -64dBm  
11ac VHT80\_MCS0: -87dBm, 11ac VHT80\_MCS9: -61dBm,  
2.4GHz:  
11g 6Mbps: -95dBm, 11g 54Mbps: -78dBm  
11n HT20\_MCS0: -95dBm, 11n HT20\_MCS7: -75dBm  
11n HT20\_MCS8: -70dBm, 11n HT40\_MCS0: -92dBm  
11n HT40\_MCS7: -72dBm, 11n HT40\_MCS9: -66dBm
- Wireless Function: Enable/Disable Wireless Radio, WDS Bridge, WMM, Wireless Statistics
- Wireless Security: 64/128-bit WEP, WPA/WPA2, WPA-PSK/WPA2-PSK encryptions

# Specifications

## Software

- Quality of Service: WMM, Bandwidth Control
- WAN Type: Dynamic IP/Static IP/PPPoE/PPTP(Dual Access)/L2TP(Dual Access)/BigPond
- Management: Access Control, Local Management, Remote Management
- DHCP: Server, DHCP Client List, Address Reservation
- Port Forwarding: Virtual Server, Port Triggering, UPnP, DMZ
- Dynamic DNS: DynDns, NO-IP, TP-Link
- Access Control: Parental Control, Local Management Control, Host List, White List, Black List
- Firewall Security: DoS, SPI Firewall, IP and MAC Address Binding
- Protocols: IPv4, IPv6
- USB Sharing: Supports Samba(Storage)/FTP Server/Media Server/Printer Server
- Guest Network: 2.4GHz guest network x 1, 5GHz guest network x 1

## Others

- Certification:  
CE, FCC, RoHS
- System Requirements:  
Microsoft Windows 98SE/NT/2000/XP/Vista™/7/8/8.1/10, MAC OS, NetWare, UNIX or Linux  
Internet Explorer 11, Firefox 12.0, Chrome 20.0, Safari 4.0, or other Java-enabled browser  
Cable or DSL Modem  
Subscription with an internet service provider (for internet access)
- Environment:  
Operating Temperature: 0°C~40°C (32°F ~104°F)  
Storage Temperature: -40°C~70°C (-40°F ~158°F)  
Operating Humidity: 10%~90% non-condensing  
Storage Humidity: 5%~90% non-condensing
- Package Contents  
Multi-Band Wi-Fi Router Talon AD7200  
Power Supply Unit  
Ethernet Cable  
Quick Installation Guide



For more information, please visit

<http://www.tp-link.com/en/products/details/AD7200.html>

or scan the QR code left

Attention: This device may only be used indoors in all EU member states and EFTA countries.

Specifications are subject to change without notice. TP-Link is a registered trademark of TP-Link Technologies Co., Ltd. Other brands and product names are trademarks or registered trademarks of their respective holders. Copyright ©2017 TP-Link Technologies Co., Ltd. All rights reserved.

TP-Link Technologies Co., Ltd.

Building 24 (floors 1, 3, 4, 5) and 28 (floors 1-4) Central Science and Technology Park, Shennan Rd, Nanshan, Shenzhen, China

[www.tp-link.com](http://www.tp-link.com)

[www.tp-link.com](http://www.tp-link.com)

TP-Link AD7200 Multi-Band Wi-Fi Router **Talon AD7200**